

Lawn Lite PURE LED

Cat. No. LL/L



PURE LED

Pure Performance

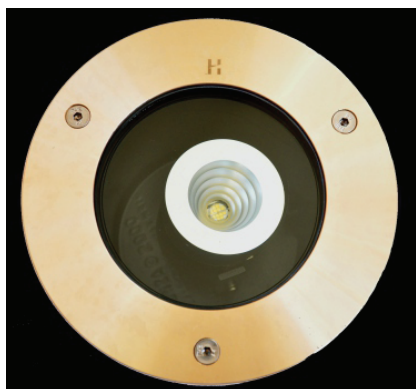
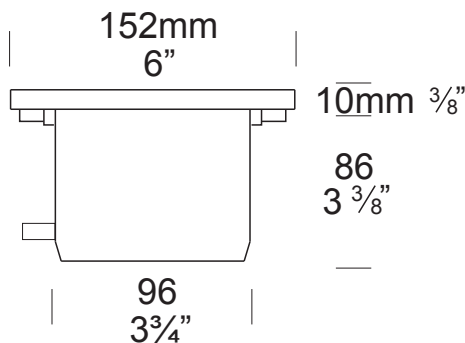

The Lawn Lite LED is designed for insertion into a lawn or garden bed and can be mowed over without damaging the luminaire. Designed so the lamp can be directed up to 20 degrees at a bush, tree, or the outside of a building, etc. without the need to remove the luminaire from the ground due to the vandal-resistant three stainless steel allen head screw fixing system which attaches the flange to the body of the luminaire. With a 'Flush Fit' lens to stop water pooling and depositing dirt on the lens. The Lawn Lite LED uses HUNZA's plug and play system for the LED engine and driver.

The Hunza PURE LED system uses Cree MTG-2 chips for maximum performance and long life. Power supply options include a choice of 12 volt integral or a remote (series connection) driver. The PURE LED system incorporates HUNZA's Plug-and-Play system for easy replacement of either the LED engine or integral driver in the field. Four beam angles, and a choice of a Warm or Cool White colour temperatures are available.

*At 700mA this fitting is the equivalent of a 35w halogen fitting.

*At 1050mA this fitting is the equivalent of a 50w halogen fitting.

Ordering Information

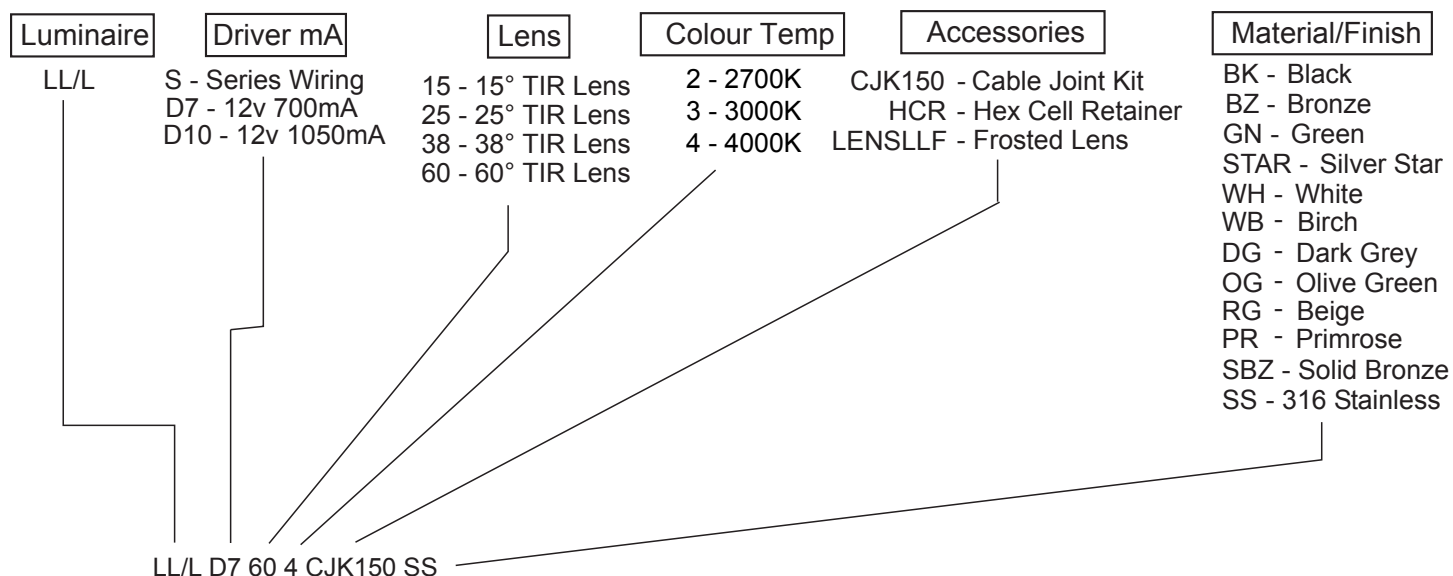

HUNZA™ PURE OUTDOOR LIGHTING

HUNZA FACTORY
130 Felton Mathew Ave
Saint Johns
Auckland 1072
New Zealand

Ph: 64-9-528 9471
Fax: 64-9-528 9361
hunza@hunza.co.nz
www.hunza.co.nz

INTERNATIONAL CONTACTS:
www.hunza.co.nz/contacts.php

Specifications may change without notice.
Manufactured in New Zealand.
© 2015 Hunza Holdings Ltd.

Luminaire Construction

CNC machined from one of the following metals:

Body:

Cast from virgin high corrosion resistant CC401 low copper aluminium alloy, with chromate substrate and high UV resistant polyester powder coat. **Colour:** Black, Bronze, Green, Silver Star, White, Birch, Dark Green, Olive Green, Beige, Primrose.

Flanges:

The flange is attached to the body by three 316 stainless steel allen head anti vandal screws and is available in either powder coated solid aluminium or CNC machined from one of the following metals:

Solid Bronze - 150mm (6") bar.

Solid 316 Stainless Steel - 150mm (6") rod.

Luminaire Weight

Alum .94kg (2lbs 1oz)

SBZ 1.14kg (2lbs 8oz)

SS 1.13kg (2lbs 7oz)

Features

Lens:

12mm (1/2") extra clear low iron flush fit shatter resistant glass. Lifetime Warranty.

Gaskets:

Nytrol 220°C (428°F).

Accessories:

Cable Joint Kit (Cat. CJK150).

Frosted Lens (Cat. LENSLLF).

Hex Cell Retainer (Cat. HCR).

Mounting

Suitable for insertion into a lawn or gardens etc. mounted level with ground surface, seated on its base.

Technical Information

Standards

AS/NZS 61046

IP56/IP66 UL 1838

LED

Cree MTG-2 Plug and Play, field replaceable LED board.

Lumen Output: 600 at 1050mA

Lumens Per watt: 100 at 6 watts

CRI Warm White (3000k): 85+

Colour Temp: 2700K, 3000K and 4000K

Power Supply

Series (External) Driver

Constant current driver

Output: 6vdc at 1050mA maximum

Integral 12 Volt Driver

Hunza™ Plug and Play Driver

Input: 12vac, 7 watt total

Output: 6vdc nominal, 350 / 700 / 1050mA

Transformer

Hunza™ Wall Mount Transformer for use with integral 12 volt driver

Reflector Beam Angles

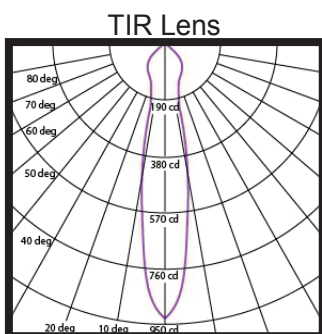

15° Angle
3000 K

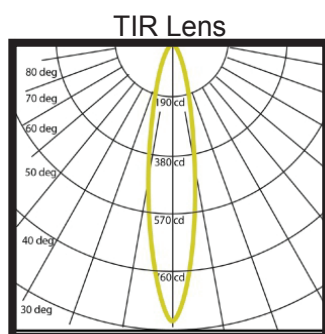

25° Angle
3000 K

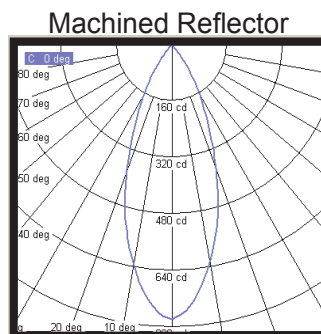

38° Angle
3000 K

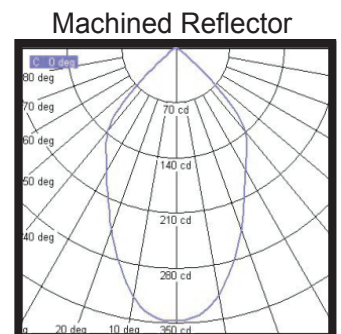

60° Angle
3000 K

HUNZA™ PURE
OUTDOOR
LIGHTING

HUNZA FACTORY
130 Felton Mathew Ave
Saint Johns
Auckland 1072
New Zealand

Ph: 64-9-528 9471
Fax: 64-9-528 9361
hunza@hunza.co.nz
www.hunza.co.nz

INTERNATIONAL CONTACTS:
www.hunza.co.nz/contacts.php

Specifications may change without notice.
Manufactured in New Zealand.
© 2015 Hunza Holdings Ltd.